

■ Features :

- Universal AC input/Full range
- Low leakage current<0.5mA
- Protections:Short circuit/Over load/Over voltage
- Cooling by free air convection
- 100% full load burn-in test
- Fixed switching frequency at 65KHz
- 2 years warranty

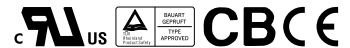

SPECIFICATION

MODEL	PT-65A			PT-65B			PT-65C			PT-65D			
OUTPUT	DC VOLTAGE	5V	12V	-5V	5V	12V	-12V	5V	15V	-15V	5V	12V	24V
	RATED CURRENT	5.5A	2.5A	0.5A	5.5A	2.5A	0.5A	5.5A	2A	0.5A	4A	2A	1A
	CURRENT RANGE	0.4 ~ 7A	0.2 ~ 3.2A	0 ~ 0.7A	0.4 ~ 7A	0.2 ~ 3.2A	0 ~ 0.7A	0.4 ~ 7A	0.2 ~ 2.6A	0 ~ 0.7A	0.5 ~ 5A	0.2 ~ 4A	0.2 ~ 1.3A
	RATED POWER	60W			63.5W			65W			68W		
	OUTPUT POWER (max.)	Rated output power for convection; 72W with 18CFM min. Forced air											
	RIPPLE & NOISE (max.) Note.2	50mVp-p	120mVp-p	50mVp-p	50mVp-p	120mVp-p	100mVp-p	50mVp-p	120mVp-p	100mVp-p	50mVp-p	100mVp-p	200mVp-p
	VOLTAGE ADJ. RANGE	CH1:4.75 ~ 5.5V											
	VOLTAGE TOLERANCE Note.3	±4.0%	±7.0%	±5.0%	±4.0%	±7.0%	±5.0%	±4.0%	±7.0%	±5.0%	±4.0%	±6.0%	±6.0%
	LINE REGULATION	±1.0%	±2.0%	±1.0%	±1.0%	±2.0%	±1.0%	±1.0%	±2.0%	±1.0%	±1.0%	±2.0%	±3.0%
LOAD REGULATION	±3.0%	±4.0%	±1.0%	±3.0%	±4.0%	±1.0%	±3.0%	±4.0%	±1.0%	±2.0%	±5.0%	±5.0%	
SETUP, RISE, HOLD TIME	800ms, 20ms, 20ms at full load												
INPUT	VOLTAGE RANGE	90 ~ 264VAC			127 ~ 370VDC								
	FREQUENCY RANGE	47 ~ 440Hz											
	EFFICIENCY(Typ.)	76%			77%			77%			79%		
	AC CURRENT	1.5A/115VAC			0.9A/230VAC								
	INRUSH CURRENT(max.)	COLD START 20A/115VAC			40A/230VAC								
	LEAKAGE CURRENT	<0.5mA											
PROTECTION	OVER LOAD	73 ~ 95W rated output power									74.8 ~ 98.6W rated output power		
		Protection type : Hiccup mode, recovers automatically after fault condition is removed.											
	OVER VOLTAGE	5.75 ~ 6.75VDC on CH1											
		Protection type : Hiccup mode, recovers automatically after fault condition is removed.											
ENVIRONMENT	WORKING TEMP.	-10 ~ +60°C (Refer to output load derating curve)											
	WORKING HUMIDITY	20 ~ 90% RH non-condensing											
	STORAGE TEMP., HUMIDITY	-20 ~ +85°C, 10 ~ 95% RH											
	TEMP. COEFFICIENT	±0.04%/°C (0 ~ 50°C) on +5V output											
	VIBRATION	10 ~ 500Hz, 2G 10min./1cycle, Period for 60min.each along X, Y, Z axes											
SAFETY & EMC (Note 4)	SAFETY STANDARDS	UL1950, TUV EN60950 Approved											
	WITHSTAND VOLTAGE	I/P-O/P:3KVAC I/P-FG:1.5KVAC O/P-FG:0.5KVAC 1min.											
	ISOLATION RESISTANCE	I/P-O/P, I/P-FG, O/P-FG:100M Ohms/500VDC											
	EMI CONDUCTION & RADIATION	Compliance to EN55022 (CISPR22) Class B											
	HARMONIC CURRENT	Compliance to EN61000-3-2,-3											
	EMS IMMUNITY	Compliance to EN61000-4-2,3,4,5,6,8,11; ENV50204, EN55024, Light industry level, criteria A											
OTHERS	MTBF	277.2K hrs min. MIL-HDBK-217F (25°C)											
	DIMENSION	127*76.2*42mm (L*W*H)											
	PACKING	0.25Kg; 54pcs/15.9Kg/1.35CUFT											
NOTE	<ol style="list-style-type: none"> 1. All parameters NOT specially mentioned are measured at 230VAC input, rated load and 25°C of ambient temperature. 2. Ripple & noise are measured at 20MHz of bandwidth by using a 12" twisted pair-wire terminated with a 0.1uf & 47uf parallel capacitor. 3. Tolerance : includes set up tolerance, line regulation and load regulation. 4. The power supply is considered a component which will be installed into a final equipment. The final equipment must be re-confirmed that it still meets EMC directives. 5. Mounting holes M1 and M2 should be grounded for EMI purposes. 												

Mechanical Specification

Unit:mm

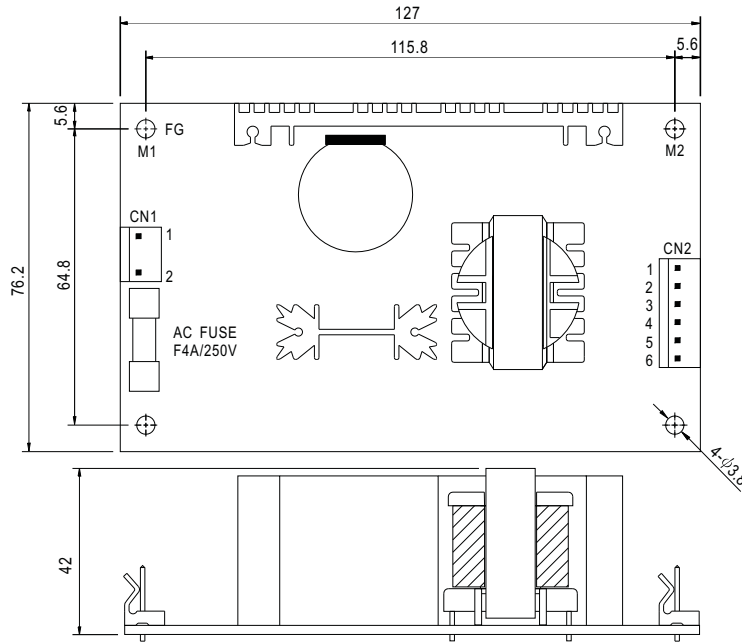

AC Input Connector (CN1) : Molex 5277-02 or equivalent

Pin No.	Assignment	Mating Housing	Terminal
1	AC/N	Molex 5195 or equivalent	Molex 5194 or equivalent
2	AC/L		

DC Output Connector (CN2) : Molex 5273-06 or equivalent

Pin No.	Assignment	Mating Housing	Terminal
1	V2	Molex 5195 or equivalent	Molex 5194 or equivalent
2,3	+5V		
4,5	COM		
6	V3		

※PIN2:+5V PIN3,4,5:COM only for PT-65D

Block Diagram

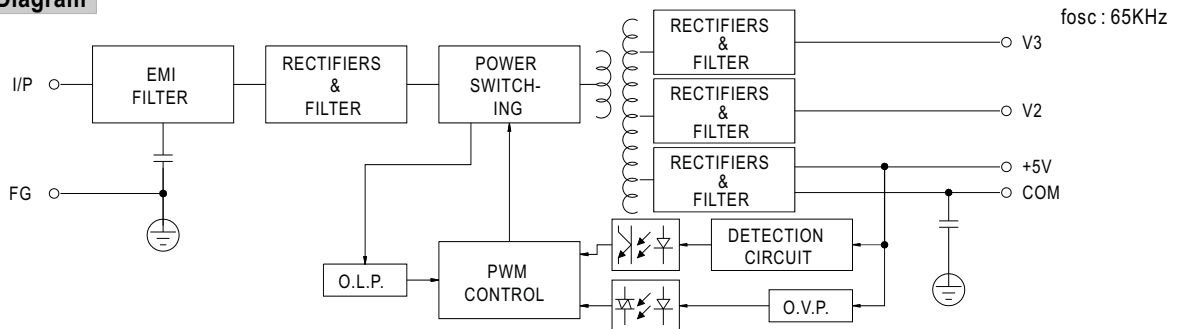

Output Derating

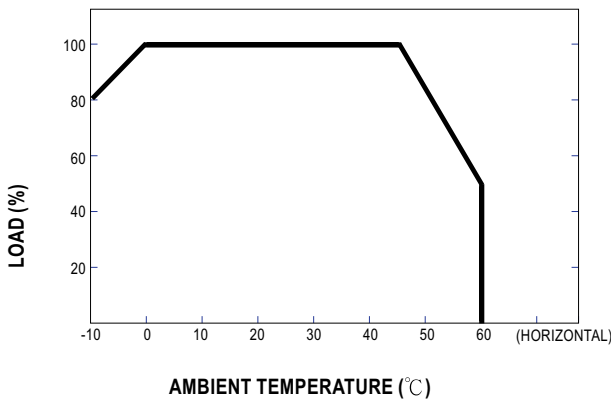

Static Characteristics (B)

